

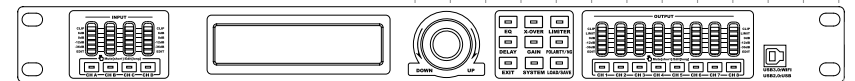

DISTRIBUTED BY

AFSP-048
SOUND PROCESSOR



Example: Use 2 central control devices to control one speaker management. Central control A adjust the gain of InA, InB. Central control B adjust the gain of Out1, Out2, and Out3.

- (1) Link the speaker management and central control devices as below pictures.
- (2) Turn on the switches of InA and InB of central control A, turn off the rests
- (3) Turn on the switches of OUT1, OUT2, OUT3 of central control B, turn off the rests

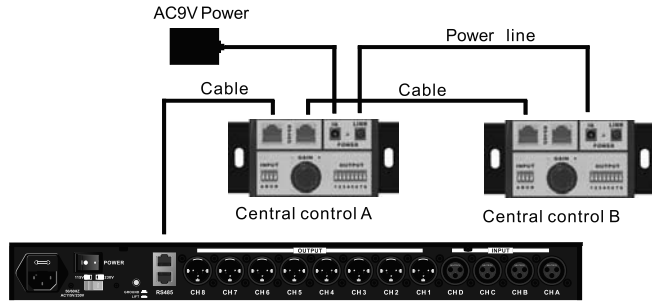

Sketch map of Linkage

Table of Contents

1. Safety Rules	2
2. Fetures	2
Packing list	3
Specification	3
3. Front Panel	4
4. Back Panel	5
5. Meaning of the sign in the operation instruction	5
6. Adjusted Parameter	5
6.1 Turn on the device	5
6.2 Adjust the parameter of Input channel	6
6.2.1 Adjust the EQ of Input Channel	6
6.2.2 Adjust the Delay of Input Channel	8
6.2.3 Adjust the Volume of Input Channel	9
6.2.4 Adjust the Polarity and Noise Limiter of Input Channel	10
6.3 Adjust the parameter of Output Channel	11
6.3.1 Adjust the EQ of Output Channel	11
6.3.2 Adjust the high and low pass of the Output Channel	13
6.3.3 Adjust the voltage limited of Output Channel	15
6.3.4 Adjust the delay of Output Channel	17
6.3.5 Adjust the Volume and Signal Source Chose of the Output Channel	18
6.3.6 Adjust the Polarity of the Output Channel	20
7. System Setup Menu	21
7.1 Device ID Setup	22
7.2 Password Setup	23
7.2.1 Eg: Lock the Voltage Limited of Output Channel	23
7.2.2 appereance of locked	25
7.2.3 Revise the lock item	26
7.2.4 Revise the Password	27
7.2.5 Remove the password	29
7.3 Power On Setup	31
7.4 Backlight Setup	32
7.5 Current Program	33
7.6 System Information	34
8. Operation Program	35
8.1 Save Program	35
8.2 Load the Program	37
8.3 Delete Program	38
8.4 Channel Copy	39
9. Others	41
9.1 Multi-channel linkage operation	41
9.2 Label Message	42

Thanks for using our Speaker Management .In order to help you to use our products very well, please read the instruction below carefully.

1.Attention

Warning: To prevent the short circuit, keep off any place of humidity.
Turn off the device immediately in case of water damage and find the right technician for reparation.
Do not open the device yourself unless by the authorized technician.
When flashes the exclamation Mark, the device is also with high voltage and the alert should be on.
When flashes the arrowhead signal, the device is with high voltage. Please do not touch the device for any reason.

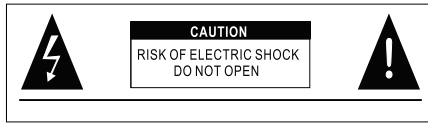

2.Features

- 96K Hz sampling frequency,32-bit DSP processor, 24- bit A/D and D/A converter.
- 6 Models available: 2Ins/4Outs, 2Ins/6Outs, 2Ins/8Outs, 3Ins/6Outs, 4Ins/6Outs,Ins/8Outs.
- USB and RS485 connector are provided to be connected with PC.250pcs of the devices can be connected together via Rs485 and it can be remote controlled far from 1500m.
- It is convenient, and conciseness to use the function buttons and coder on the panel or connect the PC with the software to set the function.
- 30 kinds of user programs can be stored into the device.
- To avoid other people to disturb the working status of the device, setting the password with the system button to lock the panel control function.
- 6 independent parametric EQ of input and output. The gain range is ± 20 dB. The EQ of output channel has two slopes: Lo-shelf and Hi-shelf.
- 2×2 4 L C D blue back light display function. 6 L E D display the exactly digital level meter, mute and edit status of input/output.
- Every input and output have delay ,phase control and mute setting, delay can reach 1000ms.
- Can adjust the gain, limiter of output channel.Choose the input signal, and copy all the parameters of one channel to another channel and joint debugging.

9.2 Label

Use PC software add and revise the lables for every channel. When edit the parameter, the lable will show with the channel NO.
For example, you add the lable "1-LOW" to Out 1, then the EQ menu will show as below:



9.3 Central Control

- (1)Gain for any channels is adjustable
- (2)One Central Control Device can control several devices, one device also can be linked with several central controls.
- (3)Via RS485 Com Port, easily linked,long distance transmission,and stable signal.
- (4)Small power, the power can be in series.

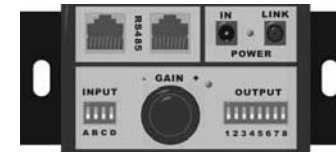

- 1.RS485 Com Port
- 2.RS485 Com Port

Several central control devices can be in series by cable. Then chose any Rs485 communicate com to connect with the communicate com of speaker management by cable. The max distance will be over 1500m.

- 3.Power Input Socket
Power of AC9V

- 4.Power Indicator light

- 5.Power Output Socket
The socket which connect to the next central control device.

- 6.4 segment coding switch
Chose the channel which need to adjust the gain.

- 7.Coder
Adjust the gain. Increase the volume with clockwise, decrease the volume with counter-clockwise.

- 8.Coder Rotation indicator light

- 9.8 segment coding switch
Chose the channel which need to adjusting the volume.

9. Others

9.1 Multi-channel data linkage operation:

For example : Set OUT1 linkage with OUT2、OUT3. Change the parameter of OUT1 , OUT2、OUT3 will also change automatically.

- (1) Press the editor of **【CH1】** till it is lighting, now it has switched into edit interface. The data of OUT1 can be edited



- (2) Press **【CH1】**、**【CH2】** at the same time , the edit light of OUT2 shows in yellow.



- (3) Press **【CH1】**、**【CH3】** at the same time , the edit light of OUT3 shows in yellow.



- (4) When the edit lights of OUT1、OUT2、OUT3 on , then OUT1、OUT2、OUT3 are under linkage operation , when adjust the parameters of OUT1 , OUT2、OUT3 will change synchronously.



- (5) Press **【EXIT】** exit the linkage operation , the edit light of OUT1、OUT2、OUT3 will off and return to main menu.



Packing list

Make sure all the items are in the package

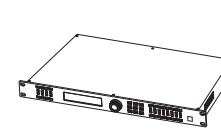

Device
Quantity: 1



Operating Instruction
Quantity: 1

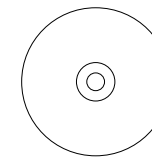

CD
Quantity: 1



USB2.0 cable
Quantity: 1



Device feet
Quantity: 4



Power line
Quantity: 1

SPECIFICATION

Inputs/Outputs	4/8
Input Impedance	Balance: 20KΩ
Output Impedance	Balance: 100Ω
PC Com Port	One USB Com Port on front panel, 2 Rs485 Com Port on back panel(RJ-45)
CMRR	>70dB@1KHz
Input Range	≤±25dBu
Frequency Response	20Hz~20KHz ±0.5dB
S/NR	>110dB
THD	<0.01% @OUTPUT=0dBu/1KHz
Crosstalk of Channels	>80dB@1KHz
Delay Time Step	Each input channel has single delay control, Range:0~1000mS; 21μS step@0~10mS; 84 μS step@ 10mS~20mS;0.5mS step@ 20mS~1000mS
Input/Output Polarity	In-phase(+) or reversed phase(-)
Input EQ	6-band parameter EQ; Frequency: 20Hz~20KHz; Gain: -20dB~+20dB; Bandwidth: 0.05oct~3oct
Input Gain	Input Gain Range: -80dB~+12dB, step@0.1dB
Mute	Mute with each Input& Output channel
Input Selection	Each input channel can be selected to each output channel
Output Gain	Range: -80dB~+12dB, step: 0.1dB
Output delay	Every input channel has independent delay control, adjust range: 0~1000ms, stepover: 21us@<10ms, ; 10ms~20ms, stepover: 84us@>20ms, stepover: 0.5ms
Crossover	Each output channel can be independently set as LPF and HPF. The parameters can be adjusted. Filter type :Linkwitz-Riley; Bessel; Butterworth. The Crossover Frequency: 20Hz~20KHz, Slope: 12dB/oct; 18dB/oct; 24dB/oct; 30dB/oct; 36dB/oct; 42dB/oct; 48dB/oct.
Limiter	Limiter with each output channel. The parameters are adjustable: Threshold value: -40dBu~+20dBu; step: 0.5dBu. Attack time: 0.3mS~200mS. 0.1mS step@0.3~1mS; 1mS step @ 1mS~100mS. Release Time: Release Time can be set to 50ms ~ 5000ms
Output EQ	Each output channel has 6-band EQ: 3 modes: Lo-Shelf/Hi-Shelf/Parameter. A: Lo-Shelf: Slope: 6dB/12dB; Frequency: 20Hz~20kHz; Gain: -20dB~20dB; B: Hi-Shelf: Slope: 6dB/12dB; Frequency: 20Hz~20kHz; Gain: -20dB~20dB; C: Parameters: frequency: 20Hz~20KHz, bandwidth: 0.05oct~3oct; Step: 0.05oct; Gain: -20dB~+20dB, Step 0.1dB
Processor	96KHz Sampling frequency, 32-bit Floating-Point DSP 24-bit A/D and D/A converter
Display	With 2*24 LCD, 6-LED input/output level. Mute and Editing mode can be displayed.
Power	≤25W
Power Supply	AC 110V/220V 50Hz/60Hz
Dimension	482×190×44 mm
Weight	3.6 (kg)

Copy from: Output1
to: InputA



(6) Press 【 Enter 】

Copy from: Output1
to: InputA



(7) The cursor flashing in the target channel, rotate the coder to chose "Output2"

Copy from: Output1
to: Output2



(8) Long press the coder

Copy Sucessfully



Prompt: "Copy Sucessfully"

Continue: YES



(9) Then appear a prompt ask if continue copy. Rotate the coder to chose "YES", go back to the 5th steps continue to copy or chose "NO" stop copying.

Continue: NO



(10) Press the coder, back to standby status.

SPEAKER MANAGEMENT





(9) Finish deleting, return to previous menu you can see the NO.10 program became blank, press **【EXIT】** several times, go back to standby screen.



8.4 Channel Copy

For example : Copy data from Out1 to Out2



(1) Anytime, can press **【LOAD/SAVE】** into program menu.



(2) Press **【Enter】**



(3) Rotate the **【coder】** choose "Channel Copy"



(4) Press **【Enter】**



(5) The cursor flashing at the channel, rotate the **【Code r】**, choose "Output1"

3. Sketch map of Front Panel



Sketch map of Front Panel

1. LCD display

Display the information of each menu.

2. Digital Encoder

- (1) Rotating: amend the parameters/change the item
- (2) Short pressing: enter or confirm, the **【enter】** button
- (3) Long pressing(at least 2 seconds): special confirm

3. 【Menu Select Keys】, function as follow:

- (1) **【EQ】** : EQ setup
- (2) **【X-OVER】** : crossover set up
- (3) **【LIMITER】** : Limiter set up
- (4) **【DELAY】** : Delay set up
- (5) **【GAIN】** : Gain set up
- (6) **【POLARITY/NG】** : Polarity set up
- (7) **【EXIT】** : Exit to the main menu
- (8) **【SYSTEM】** : referring information of system
- (9) **【LOAD/SAVE】** : pre-load setup and save the information of set up when parameters under the editing, press (1)、(2)、(3)、(4)、(5)、(6) can enter the right menu, otherwise in valid.
- press (7) at anytime can exit and cancel the operating
- press (8)、(9) at anytime can enter to the main system menu

4. LED display

- 6-LED input/output level
- (1) CLIP, the light be red when the signal distortion;
- (2) LIMIT, the light be yellow if the signal over the initialization;
- (3) -36dB - 0dB3-LED the light will be green;
- (4) EDIT indicate yellow light, shows the operating channel.

5. Input mute/Edit key

【CHA】、**【CHB】**、... **【CHD】**

- (1) One-touch press : Mute/non-mute switch. The red light will be on when mute.
- (2) Continuous initialization press(at least 2seconds) : enter the output edit interface, the detail please refer to the part of "input and output function instruction".

6. Output mute/Edit key

【CH1】、**【CH2】**、... **【CH8】**

- (1) One-touch press : Mute/non-mute switch. The red light will be on when mute
- (2) Continuous initialization press(at least 2seconds) : enter the output edit interface the detail please refer to the part of "input and output function instruction"

7. USB COM Port

Connect with PC. Through PC interface software, the referring Parameters can be adjusted. And then it will influence the inputs and outputs.

4. Sketch map of back panel

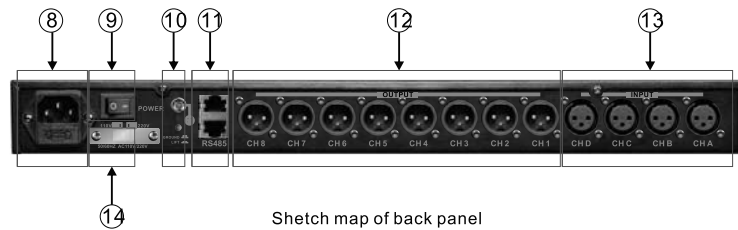

Sketch map of back panel

8.AC Power Input Block

In accordance with the instruction of gears on the power communication,

9.Power switch

Press the switch , access input voltage, and it will work normally.

10.Ground-Column

The common Ground COM of classis.

11.RS485 COM port

RS485 COM for speaker managements linking with the computer, through USB or 232 converter.It can link 250 sets at the most; also it can be controlled by computer even it is 1500m way

12.Output channel

8 output channels , marked as CH1~CH8. They are CH1,CH2,CH3 ...CH8.



13.Input channel

4 input channels , marked as CHA~CHD. They are CHA , CHB, CHC,CHD

14.Power Converter Switch

In oder to protect the device,please do select the corresponding gear of input voltage, there are two AC one is 110V,another is 220V.

5. Meaning of the sign in the operation instruction

1. Symbol **【 】** stands for the button of the panel
2. Symbol “ ” stands for the content display in LCD
3.  stands for press the button on the panel
4.  Stands for rotate the coder on the panel

8.3 Delete Program

For example : delete the NO.10 program , resume the default program.

- (1)Anytime , can press **【LOAD/SAVE】** to enter program menu.
- (2)Rotate the **【coder】** choose submenu "2.Save Program".
- (3)Press **【Enter】**
- (4)Rotate the **【coder】** choose "default"
- (5)Pres **【Enter】**
- (6)The cursor flashing at the program NO.rotate the **【coder】** choose NO.10
- (7)Press **【Enter】**
- (8)Clue to continue or not , press **【Enter】** to continue.Or rotate the **【coder】** choose "No" to cancel it , return to standby screen

8.2 Load Program

For example : Load the NO.10 program.

- (1) Anytime, press **【LOAD/SAVE】** enter to the program menu.
- (2) Press **【Enter】**
- (3) Rotate the **【Coder】** choose "group Load"
- (4) Press **【Enter】**
- (5) The cursor flashing at the program NO., Rotate the **【coder】** choose NO.10.
- (6) Press **【Enter】**
- Clue to "Waiting Loading....."
- Clue to "Loading Successfully"
- Return back to standby screen automatically.

6.Parameters adjustment

6.1 Turn on the device

Connect the AC Power with power wire, check the power converter switch correct or not. Turn on the power, then the device start Initialize.

Start the panel as follow:



After 9 second, system finished the initialization, enter the standby status. You can setup the contents of standby screen via PC software.



6.2 Adjust the parameters of Input channel

Press the menu enter button, enter the right menu to adjust the parameters, input channel can into next menu : **【EQ】**、**【DELAY】**、**【GAIN】**、**【POLARITY/NG】**, below are the flow chart of how to adjust the parameters of each menu:

6.2.1 Adjust the EQ of Input channel

For example : Adjust EQ3 frequency of INA as : 397Hz , Gain : 2dB , Qfact : 0.8Oct.

- (1) Long press the button **【CHA】**, the edit light of CHA shows yellow, system enter the menu of EQ's submenu, EQ1.
- (2) Press the button of **【EQ】**, submenu will change among EQ1 ~ EQ6, choose EQ3.
- (3) The cursor flashing at the frequency, rotate the coder to adjust the frequency as "397Hz".

(4) Press the **【Enter】** button, the cursor flashing at the gain.



(5) Rotate the **【coder】**, adjust the gain as "+2.0dB"



(6) Press **【Enter】**, the cursor flashing at the Q fact.



(7) Rotate the **【coder】**, adjust the Q fact as "0.80Oct"

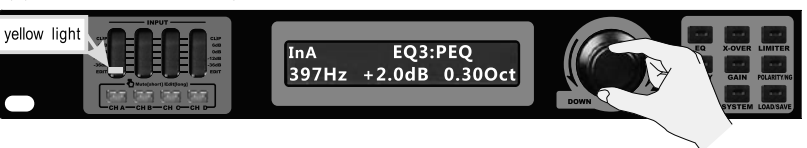

(8) Finish adjustment, press **【EXIT】**, return to standby status, the yellow edit light of CHA off at the same time.

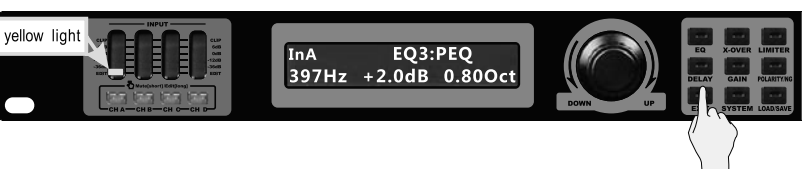

(8) Key in program name. The first letter of the name flashing, rotate the **【coder】**, choose the letter 'm'



(9) Press **【Enter】**



(10) The 2nd letter of the name flashing, repeat the 8,9 steps, key in "my program 10". After key in the last letter '0', long press the **【coder】**



Clue to "StroingSucessfully"



Return to standby screen automatically.

8. Program Set up

8.1 Save Program

For example : save the current setting parameters as program, NO is 10 , name is my program 10

(1) Anytime, press **【LOAD/SAVE】** enter the program menu.

(2) Rotate the **【coder】** choose submenu "2. Save Program".

(3) Press **【Enter】**

(4) Rotate the **【coder】** choose "store"

(5) Press **【Enter】**

(6) The cursor flashing at the program NO., rotate the **【coder】** choose NO.10

(7) Press **【Enter】**

6.2.2 Adjust the Delay of Input Channel

For example : adjust the delay of INA as 9.996ms.

(1) Long press **【CHA】**, the yellow edit light of CHA on, system enter the EQ1 submenu of EQ acquiescently

(2) Press **【DELAY】**, enter the menu of DELAY.

(3) Rotate the **【coder】**, adjust the delay as 9.996ms.

(4) Finish setting, press **【EXIT】** return to standby screen.

6.2.3 Adjust the Gain of Input channel

For example : Adjust the gain of INA as +3dB

(1) Long press **【CHA】** button, the yellow edit light of CHA on, system enter the submenu EQ1 of EQ defaultly



(2) Press **【GAIN】**, enter the menu of GAIN.

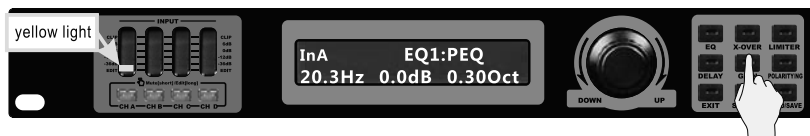

(3) Rotate the **【coder】**, adjust the gain as +3dB.



(4) Finish setting, press **【EXIT】** button resume standby screen.



7.6 System Information

Check the edition NO. of the system software.



(1) Anytime, can press **【SYSTEM】** enter into system menu.



(2) Rotate the **【coder】** choose the submenu "6.System Information".



(3) Press **【Enter】** button



You can see the edition of the sample software is "G-DV1.07"



(4) Press **【Enter】**.



(5) Back to previous menu automatically, press **【EXIT】** button till resume the standby screen.



7.5 Current Program
Check the current program name.

(1) Anytime, can press **【SYSTEM】** button enter the system menu.

(2) Rotate the **【coder】** choose the submenu "5.Current Program".

(3) Press **【Enter】**

You can see the sample loading program name is "my program"

(4) Press **【Ether】**

(5) Return back to previous menu automatically, press **【EXIT】**, resume the standby screen.

6.2.4 Adjust the Polarity and NOISE-Gate of Input channel
For example : Adjust the polarity of INA as reversed Phase , Noise-Gate as -80dB.

(1) Long press **【CHA】** button, the yellow edit light of CHA on, system enter the submenu EQ1 of EQ defaultly.

(2) Press **【POLARITY/NG】**, enter the menu of POLARITY/NG.

(3) The cursor flashing at the polarity, rotate the **【coder】** adjust the polarity as "-".

(4) Press **【Enter】** button, the cursor flashing at the Noisegate.

(5) Rotate the **【coder】** to adjust the noisegate as "-80dBu"

(6) Finish setting, press **【EXIT】** button return back to standby screen.

6.3 Adjust the parameters of the Output channel

Press the button of the menu, enter the relative menu to adjust the parameters, the output channel can enter below menu: **【EQ】**、**【X-OVER】**、**【LIMITER】**、**【DELAY】**、**【GAIN】**、**【POLARITY/N G】** , below are the flow chart of how to adjust the parameters of each menu:

6.3.1 Adjust the EQ of Output channel

For example : Adjust the EQ3's parameters of OUT1 as EQ mold: lowcut; frequency :102Hz;Gain : 2dB;

(1)Long press **【CH1】** button, the yellow edit light of Ch1 on , system enter the submenu EQ1 of EQ defaultly.



(2)Press **【EQ】** button , submenu switch among EQ1 ~ EQ6,choose EQ3.



(3)The cursor flashing at the EQ mould, rotate the **【coder】** adjust the mould to Lo-shelf.



(4)Press **【Enter】** button,the cursor flashing at the frequency.



(5)Rotate the **【Coder】** ,adjust the frequency as 397Hz



7.4 Backlight setup

For example : The background light will go off in 10 seconds when the power is on.And then the LCD will enter the power-saving mode.

- (1)Anytime , can press the **【SYSTEM】** button enter the system menu.
- (2)Rotate the **【coder】** choose the submenu "3.Backlight Setup"
- (3)Press **【Enter】**
- (4)Rotate the **【coder】** choose"10s"
- (5)Press **【Enter】**
- (6)Finish setting , return to previous menu automatically,press **【EXIT】** button till resume standby screen.

7.3 System Setup Menu

For example : Setup the power on automatic loading program as No.1 program.

(1)Anytime , can press the **【SYSTEM】** button enter the system menu.

(2)Rotate the **【Coder】** choose the submenu "3.Power On Setup".

(3)Press **【Enter】**

(4)Rotate the **【Coder】** , choose "3.Load"

(5)Press **【Enter】**

(6)Finish setting , return back to previous menu automatically, press **【EXIT】** till resume to the standby screen.

(6)Press **【Enter】** button, the cursor flashing at the Gain

(7)Rotate the **【Coder】** adjust the gain as +2.0dB

(8)Press **【Enter】** button, the cursor flashing at the slope

(9)Rotate the **【Coder】** adjust the slope as "12dB/Oct"

(10)Finish setting , press **【EXIT】** button resume to standby screen.

6.3.2 Adjust the HPF and LPF of Output channel.

For example : adjust the HPF of OUT1 as 102Hz; mould : Bessel;slope:30dB/Oct.

(1)Long press **【CH1】** button , system enter the EQ1 submenu of EQ defaultly.



(2)Press **【X-OVER】** button, enter LPF menu, press the button again then enter HPF menu. Defaultly set as off status.



(3)Rotate the **【coder】** widdershins , turn on the LPF function.



(4)The cursor flashing at the frequency,rotate the **【coder】** adjust



(5)Press the **【 Enter】** button,the cursor flashing at the mould.

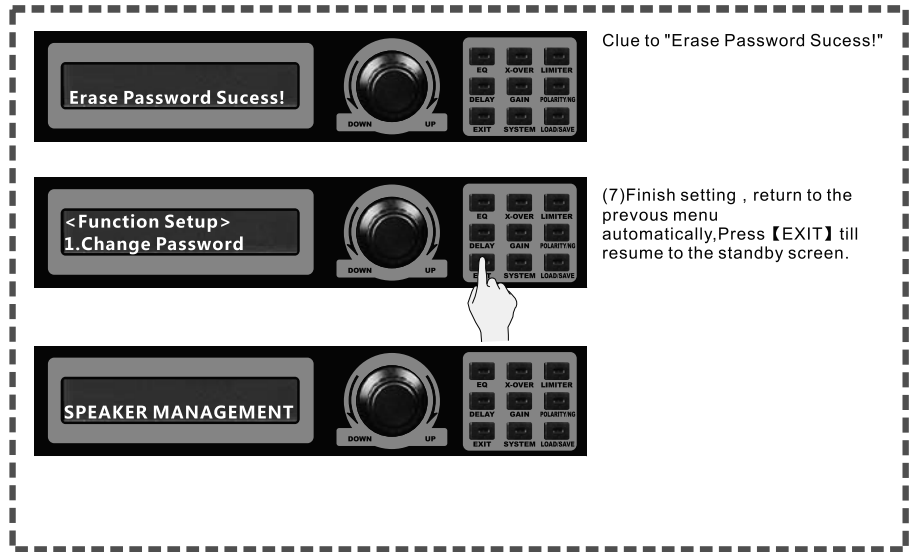

7.2.5 Erase the Password.

(1) Anytime, press the **【SYSTEM】** button enter the system menu.

(2) Rotate the **【Coder】** choose the submenu "2.Lock Menu Setup"

(3) Press **【Enter】** button enter the menu.

(4) Key in the preset password. Rotate the **【Coder】**: choose the letter
【Enter】 button: confirm key in the letter
【EXIT】: backspace

If password wrong, it will hint "Password Error, Input Password Again", require enter again.

If password correct, it will hint "Password Right", then enter the next menu.

(5) Rotate the **【Coder】**, choose "2.Erase Password"

(6) Press **【Enter】** button.

(6) Rotate the **【coder】** adjust the mould to Bessel

(7) Press **【Enter】** button, the cursor flashing at the slope.

(8) Rotate the **【coder】** adjust the slope as "30dB/Oct"

(9) Finish adjustment, press **【EXIT】** button resume to standby screen.

6.3.3 Adjust the Limiter of the Output channel

For example : adjust the limiter of Out1 as : +3.0dB;attack time:20ms,release time:1000ms.

(1)Long press the **【CH1】** button , system enter the EQ1 submenu of EQ.



(2)Press **【LIMITER】** button , enter the limiter menu , defaultly in off status.



(3)Contrarotate the **【Coder】** , turn on the limiter.



(4)The cursor flashing at the limiter, rotate the **【Coder】** adjust as +3.0dB



(5)Press the **【Enter】** button , the cursor flashing at the starting time.



(7)Key in 6 digit new password .For example use"ABCDEFG"as password ,the cursor flashing at the first letter ,rotate the **【Coder】** , choose letter"A"

(8)Press **【Enter】** button , the cursor

(9)Repeat the 6、7 steps, finished key in 6 digit password.

Clue to"Change Password Success!"

(10)Finish amendment , return back to previous menu automatically ,press the **【EXIT】** button till resume to the standby screen.

7.2.4 Revise the password

(1)Anytime , can press the **【SYSTEM】** button enter the system menu.

(2)Rotate the **【Corder】** choose the submenu "2.Lock Menu Setup"

(3)Press **【Enter】** button enter the menu.

(4)Key in the pre-set password. Rotate the **【Corder】** : choose the letter **【Enter】** : confirm the key letter **【EXIT】** : Backspace

If the password is wrong,it hints "Password Error,Input Password Again" require you enter again.

If the password is right,it hints "Passowrd Right" enter the next menu.

(5)Rotate the **【Corder】** , choose "1.Change Password"

(6)Press **【Enter】**

(6)Rotate the **【Corder】** adjust the the attack time as 20ms.

(7)Press the **【Enter】** button , the cursor flashing at the release time.

(8)Rotate the **【Corder】** , adjust the release time as 1000ms.

(9)Finish setting , press **【EXIT】** button and resume to the standby screen.

6.3.4 Adjust the Delay of Output Channel

For example : Adjust the delay of OUT1 as 9.996ms.

(1) Press the **【CH1】** button , system enter the EQ1 submenu of EQ defaultly.



(2) Press the **【DELAY】** button , enter the DELAY menu.



(3) Rotate the **【Coder】** , adjust the delay as 9.996ms.

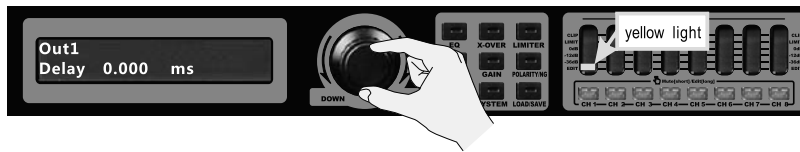

(4) Finish setting , press the **【EXIT】** button resume to the standby screen.



7.2.3 Revise the lock item.



(1) Anytime , can press the **【SYSTEM】** button enter the system menu.



(2) Rotate the **【Coder】** choose the submenu "2.Lock Menu Setup"



(3) Press the **【Enter】** button enter the menu.



(4) Key in the pre-set password. Rotate the **【Corder】** : choose the letter **【Enter】** : confirm the key in letter **【EXIT】** : Backspace



If the password key in wrongly, it will hint "Password Error,Input Password Again",require key in again.



If the password key in correctly,it will hint "Passowrd Right"enter the next menu.



(5) Rotate the **【Coder】** , choose "3.Change Lock Menu"



Press **【Enter】** button,enter the lock menu, revise the lock item.The operate steps please refer to NO.10 to NO.16 steps of 7.2.1"Lock in setup menu"

7.2.2 Phenomenon of lock the parameters

Suppose locked the limiter of the output channel according to 6.2.1 , then the parameters of limiter can not be revise. Phenomenon as below:

(1) Press the **【CH1】** button , system enter the EQ1 submenu of EQ.



(2) Press the **【LIMITER】** button.



(3) Hints the limiter has been locked, please unlock it. The unlock method please refer to next paragraph "revise lock item"



(4) Press the **【EXIT】** button resume to standby screen.



6.3.5 Adjust the Gain of Output channel and signal chosen.

For example : Adjust the Gain of OUT1 as +5dB; choose the signal as INB.

(1) Long press the **【CH1】** button , system enter the Eq1 submenu of EQ defaultly.



(2) Press the **【GAIN】** button , enter the Gain Menu.



(3) The cursor flashing at the Gain , rotate the **【Coder】** , adjust the gain as +5dB.



(4) Press the **【Enter】** button , the cursor flashing at the signal INA



(5) Rotate the **【Coder】** choose "OFF"



(6) Press **【Enter】** button , the cursor flashing at the signal INB.



(7) Rotate the **【Coder】** , choose "ON"

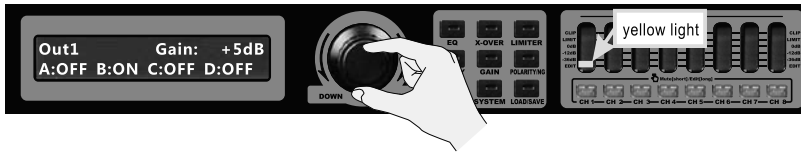

(8) Finish setting , press **【EXIT】** button resume to standby screen.

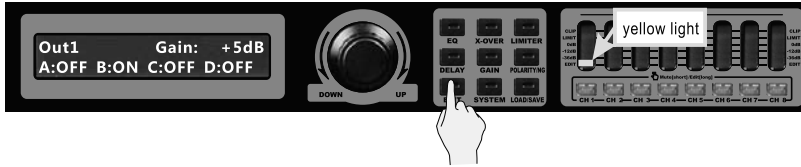

(9) Hints "Create Password Success!"



(10) Enter the lock in setup menu automatically, rotate the **【Coder】** choose "2.Output Set"



(11) Press the **【Enter】** enter the next menu



(12) Rotate the **【Coder】** choose "5.Limite"



(13) Press **【Enter】** button , the cursor flashing at the OFF



(14) Rotate the **【Coder】** choose ON



(15) Press **【Enter】**



(16) Finish setting , press **【EXIT】** several times till resume to the standby screen.



7.2 Lock menu set up

7.2.1 For example : Lock the limiter of the output channel

- (1) Anytime, press the **【SYSTEM】** button enter the system menu.
- (2) Rotate the **【Coder】** choose the submenu "2.Lock Menu Setup"
- (3) Press the **【Enter】** button enter the menu.
- (4) Rotate the **【Coder】** choose the submenu, choose setup or not setup the password to enter the sample for choose the setup password.
- (5) Press **【Enter】**
- (6) Key in 6 digit password. Use "ABCDEFG" as password for example, the cursor flashing at the first letter, rotate the **【Coder】** choose 'A'
- (7) Press **【Enter】**, the cursor flashing at the 2nd letter.
- (8) Repeat the 6. 7steps, key in 6 digit password.

6.3.6 Adjust the phase of output channel

For example : Adjust the phase of OUT1 as reversed phase.

- (1) Long press the **【CH1】** button, system enter the EQ1 submenu of EQ defaultly.
- (2) Press the **【POLARITY/NG】** button, enter to the menu of POLARITY/NG.
- (3) Rotate the **【Coder】**, adjust the phase as "-"
- (4) Finish setting, press the **【EXIT】** button, resume to the standby screen.

8. System Menu

Press **[SYSTEM]** button, enter the system menu, includes below 6 menu:

1. Device ID Setup

Set up the ID NO.. And it is used PC software to choose connector with the nominated device.

2. Lock Menu Setup

After setup the parameters, in order someone revise the parameters, you can set password with 6 digital.

Parameters of lock setup menu :

Input	Output	System
1.Noisegate	1. Gain	1. Load Data
2. Gain	2. Delay	2. Save Data
3. Delay	3. Polarity	3. Erase Data
4. Polarity	4. X_over	4. Device ID
5. EQ	5. Limite	5. Backlight
6. Mute	6. Matrix	6. Edit Key
7. CH_Mark	7. EQ	7. Channel Copy
8. LINK	8. Mute	8. Power On
9. All Locked	9. CH_Mark	9. All Locked
10. LINK		
11. All Locked		

3. (Power On Setup)

Set up extra action of turn on the device.

- (1) Keep State
- (2) All Mute
- (3) Load

4. (Backlight Setup)

Set up the LCD backlight

- (1) Open: always light
- (2) 10s: The backlight will go off in 10 seconds if no operation.

5. (Current Program)

Check the current program name

6. (System Information)

Check the system version information.

Following, let's introduce the operation procedure of each submenu :

8.1 Revise the device ID

For example: Revise the device ID as 5.

(1) Anytime, press the **[SYSTEM]** button enter the system menu.

(2) Press **[Enter]** button, enter the next menu.

(3) Rotate the **[Coder]** adjust as 5

(4) Press **[Enter]**

(5) Finish setting, press the **[EXIT]** button several times till resume to the standby screen.